

Series 381

1 Watt, 5/8 in. Diameter

Conductive Plastic Potentiometer

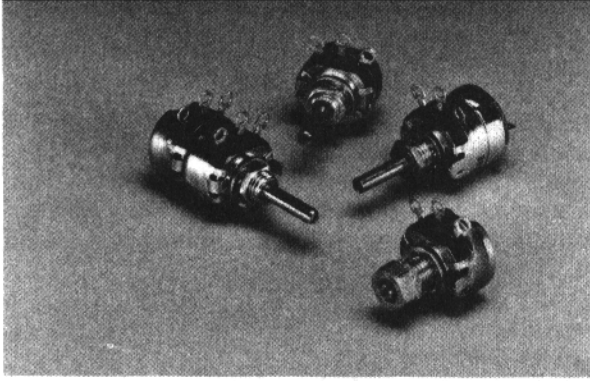

Description

Series 381 — the original “Quiet One.” This 1/2 in. diameter, one-watt, conductive-plastic potentiometer features a highly reliable resistive element offering 1% dynamic noise and 5% independent linearity. Series 381 is manufactured to meet MIL-R-94 specifications where applicable.

Features

- *Wide resistance range*
- *Long rotational life*
- *Small size*
- *Superior dynamic noise*
- *Stackable*

Series 381 Electrical Specifications

Resistance Range

Linear 100 Ω to 5 Megohms. Tapered 500 Ω to 2.0 Megohms. See Chart B and C on pages 54 and 55 for explanation of tapers. Special tapers available.

Resistance Tolerance

Linear up to 500K Ω \pm 10%; above 500K Ω \pm 20%.
Tapers up to 100K Ω \pm 10%; above 100K Ω \pm 20%.

Taper Tolerance

\pm 20% of nominal resistance at 50% \pm 3% mechanical rotation.

Voltage Coefficient

.008% per volt, maximum

Linearity

\pm 5% independent

End Resistance

Linear units: 4 Ω maximum for total resistance up to 250K Ω . 10 Ω for resistances over 250K Ω . Tapered units: high end of element 1% of total resistance or 4 Ω , whichever is greater, low end same as for linear units.

Dynamic Noise

Linear single control; maximum initial noise level of 1% of total resistance.

Static Noise

A noise quality index expressed in decibels (db) with the contact spring stationary. Up to 30K Ω -20 db; 100K Ω -12 db; 1 Megohm +3 db.

Continuity

Measurement of any spurious variations in the electrical output not present in the input made over the total electrical rotation with the control being used as a rheostat. 2% resistance deviation at blend areas. 5% resistance deviation at end resistance sections.

Power

1 watt at 70°C (single section only) continuous power rating for linear tapers, but voltage not to exceed rating--bushing mounted controls only. For printed circuit mounting derate power by 50%. See Chart A, page 62.

Derating

Derate power linearly from full power at 70°C to zero power at 120°C. Derate all non-linear tapers by 50%. Derate power 50% for phenolic or ceramic mounting in place of metal panel.

Multiple Resistor Power Derating

The maximum permissible power dissipation in one resistor element is a function of the power dissipation in the other elements. The maximum continuous power rating in watts with all resistor elements active in the circuit are as follows:

$$(W_{\text{panel}}/1.0)^2 + (W_2/0.8)^2 + (W_3/0.8)^2 = 1.0 \text{ maximum}$$

Where W_{panel} = watts in entire first panel resistor.

Element; W_2 = watts in entire second or middle resistor.

Element; W_3 = watts in entire third or rear resistor.

Electrical Specifications continued, next page

Electrical Specifications continued

Working Voltage

350 Vdc across end terminals, but power not to exceed rating.

Dielectric Strength

1000 Vac for 60 seconds @ ATM pressure;
450 Vac for 60 seconds @ 3.4 in. (86.36mm) Mercury.

Insulation Resistance

1000 Megohms minimum for clean and dry conditions at 25°C

Electrical Rotation

300° ±5° without switch; 320° ±5° with switch

Effective Rotation

270° +0°/-10° without switch

Series 381 Mechanical Specifications

Shafts

(Single, dual & dual concentric controls) standard diameter .125 in. (3.18 mm) brass, nickel-plated. Standard length every 1/16 in. (1.59mm) from 5/16 in. (7.94mm) minimum, to 3 in. (76.2mm). Available in round, slotted or flatted configurations. Other shaft configurations available. Dual concentric tubular outer shaft 0.125 in. (3.18mm) diameter, solid inner shaft 0.078 in. (1.98mm) diameter. Shafts also available in stainless steel and special lengths. All shaft lengths measured from mounting surface (FMS).

Bushings

1/4 in. (6.35mm) - 32 NEF-2A thread.

<i>Bushing Type</i>	<i>Standard in.</i>	<i>Length mm</i>
Plain	.250	6.35
	.375	9.52
Shaft Locking	.375	9.52
Panel & Shaft Seal (Panel seal obtained by use of washer)	.250	6.35
	.375	9.52

Other bushing lengths available.

Hardware

Mounting hardware available

- a.) Hex mounting nut, 1/4 in. (6.34mm) x 32-NEF-2A thread, 5/16 in. (7.94mm) across flats, 1/16 in. (1.59mm) thick.
- b.) Internal tooth lockwasher 13/32 in. (10.32mm) OD x .018 in. (0.045mm) thick.
- c.) Jam hex nut 5/16 in. (7.94mm) across flats, 5/32 in. (3.97mm) thick, supplied with locking type bushings.

Weight of Controls

Single section 0.017 lb. (7.71 grams).

Non-Turn Device

Two locating pins can be supplied for indexing the 381 controls with respect of the surface on which they are mounted. Either or both of these pins can be bent over the faceplate. Unless otherwise specified, controls are supplied in accordance with option Number 1, in figure 6, page 64.

Rotational Torque

Single control 0.2 to 6 oz. in. Torque variation within a control 1 1/2 oz. in. Single control with shaft seal 0.5 oz. in. nominal. Single control with shaft locking feature and jam nut tightened to 10 lb. in., starting torque is 20 oz. in. minimum.

Stop Torque

6 lb. in. minimum;
2 lb. in. minimum on dual concentric controls;
Delrin and tubular high voltage shafts 2 lb. in.;
3.5 lb. in. minimum on single controls with a switch.

Construction

Materials are corrosion resistant and non-magnetic. Housing is dust and splash proof. Cover to base is epoxy sealed. Terminals are molded into base and are treated for solderability per MIL-STD-202 Method 208.

High Voltage Construction

Insulated shaft and bushing available in combination, with 6,000 Vdc minimum breakdown voltage.

High Torque

High torque construction available 2 to 10 oz. in.

Attenuators

Please contact factory for complete details.

Marking

The component identification will normally appear on rear surface without switch; on periphery when switch is used. Unless otherwise specified, marking will consist of

- a) Customer part number or Clarostat part number,
- b) EIA source and date code.

Series 381 Environmental Specifications

Low Temperature Storage

Less than 2% change in the total resistance as a result of the storage test.

Low Temperature Operation

Less than 3% change in the total resistance as a result of the low temperature operation test at -40°C, and starting torque of 30 oz. in. maximum.

Thermal Cycling

Less than a 4% change in total resistance as a result of 5 cycles at -55°C to +120°C. There can be no mechanical damage and electrical discontinuity nor loosening of assemblies.

Environmental Specifications continued, next page

Environmental Specifications continued

Moisture Resistance

10% maximum total resistance change, when tested per method 103 of MIL-STD-202 for 96 hours

Insulation Resistance

100 Megohms minimum to moisture test method 106 of MIL-STD-202

Vibration, High Frequency

No intermittent contacts or open circuits when tested per method 204 condition C of MIL-STD-202. Resistance setting change is 5% maximum between L (CCW) terminal and C terminal. The total resistance change is 2% maximum between L & R terminals.

Shock

The total resistance setting change is 2% maximum between L & R terminals and 5% maximum when tested per 213 condition I of MIL-STD-202, as measured between left (CCW) terminal and center terminal.

Resistance to Soldering Heat

Less than a 2% maximum change in total resistance. Terminals immersed for 5 seconds in 350°C solder pot.

Corrosion (salt spray)

No visible corrosion after a 96 hour spray test. Tested per method 101 of MIL-STD-202. Unit to be mechanically operable.

Series 381 Operational Specifications

Load Life

10% maximum change in resistance and within end resistance limits, with rated power across element at 70°C ambient temperature. Power 1.5 hours "on", 0.5 hours "off". Designed to meet MIL-R-94C performance characteristics, where applicable.

Rotational Life

10% maximum resistance change up to 25,000 cycles under load

Figure 1
Chart A

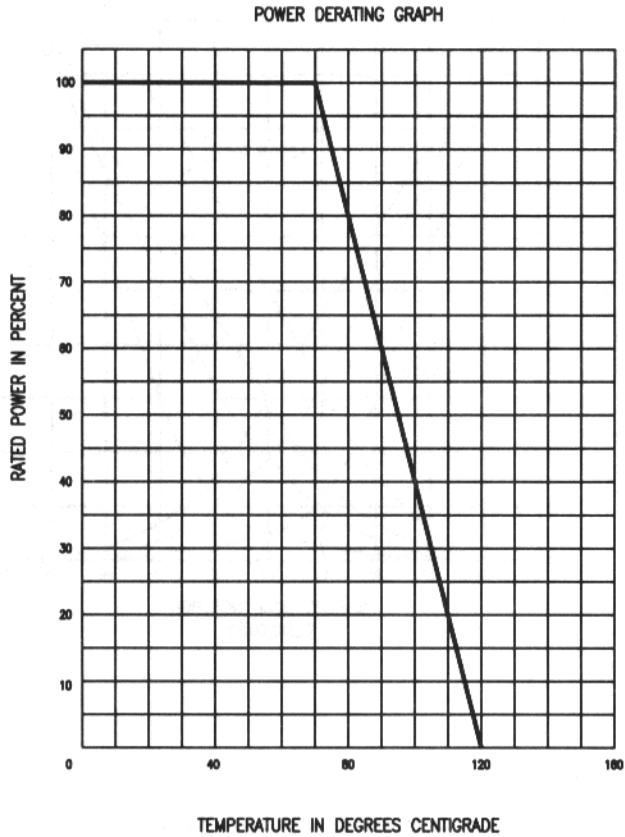
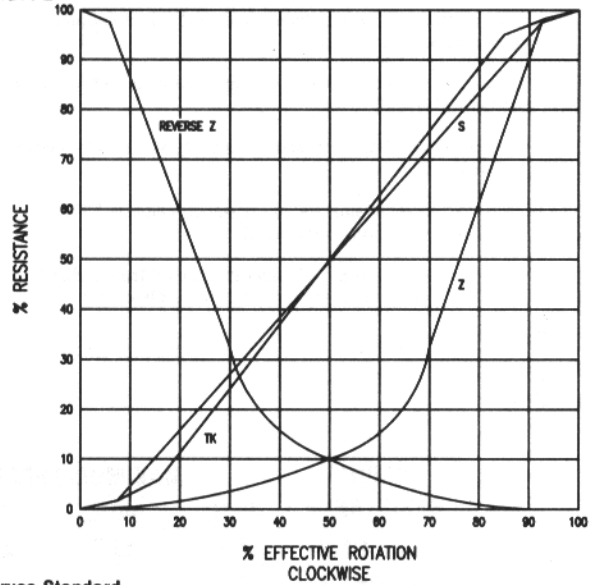

Figure 2
Chart B



Curves Standard

The "S" taper is linear, the change in resistance value being directly proportional to the degree of rotation. It can be used either as right-hand or left-hand taper.

The "Z" taper attains 10% resistance value at 50% of clockwise rotation (left-hand).

The reverse "Z" taper attains 10% resistance value at 50% of counter-clockwise rotation (right-hand).

The "TK" taper has a smooth resistance output blend from hop off to total resistance by use of a "joiner" section.

Figure 3
Chart C

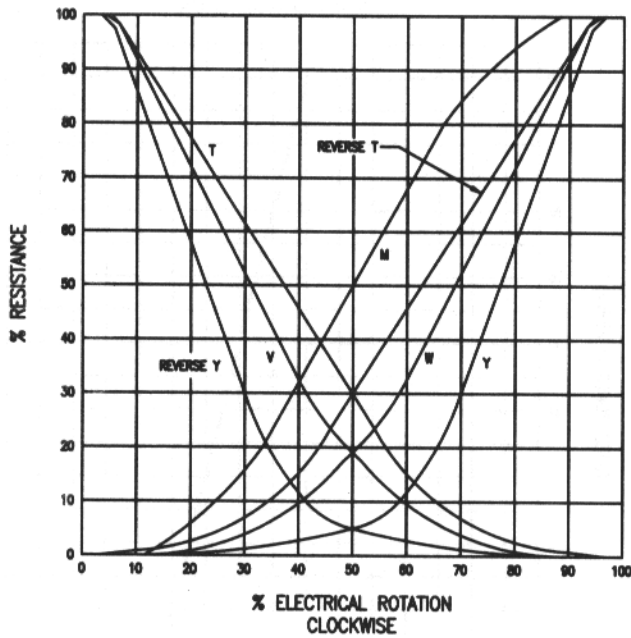

Curves Special

The "W" taper attains 20% resistance value at 50% of clockwise rotation (left-hand).

The "V" taper attains 20% resistance value at 50% of counter-clockwise rotation (right-hand).

The "T" taper attains 30% resistance value at 50% of counter-clockwise rotation (right-hand).

The reverse "T" taper attains 30% resistance value at 50% of clockwise rotation (left-hand).

The "Y" taper attains 5% of resistance value at 50% of clockwise rotation (left-hand).

The reverse "Y" taper attains 5% of resistance value at 50% of counter-clockwise rotation (right-hand).

The "M" taper is such that a "W" taper is attained from either the "L" or "R" terminal to the center tap terminal of the element.

Figure 4
Chart D

NOMINAL RESISTANCE	MAXIMUM PERCENT TEMPORARY RESISTANCE FROM 25°C						
	-55°C	-40°C	0°C	+25°C	+85°C	+105°C	+120°C
100 OHMS	±5.0	±3.0	±1.5	0	±1.5	±2.5	±3.5
10K OHMS	+5.5	+4.0	+2.0	0	±2.5	±3.0	±4.0
100K OHMS	+6.5	+5.5	+2.0	0	±3.0	±4.0	±5.5
1 MEGOHMS	+9.0	+8.0	+2.5	0	±3.5	±5.5	±7.0

FOR NON-LINEAR TAPERS, MULTIPLY CHART VALUES BY 1.25

Figure 5

Series 381 Single Potentionmeter Construction

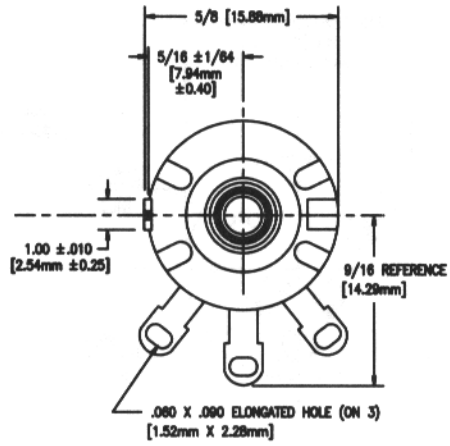
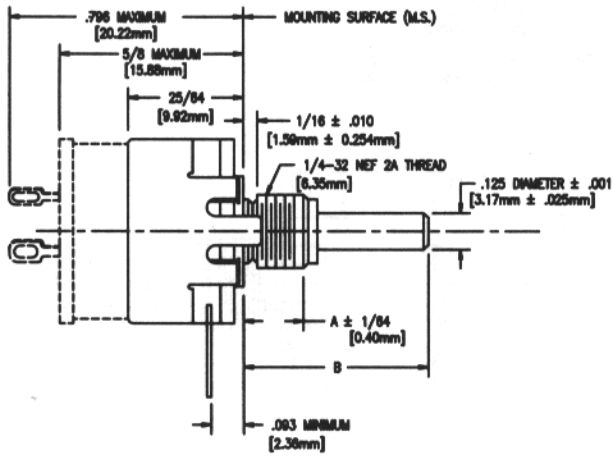

A & B & C DIMENSIONAL VARIABLE. TOLERANCES NOT SPECIFIED ± 1/32 [0.80mm]

Figure 6

Series 381 Non Turn Device Option

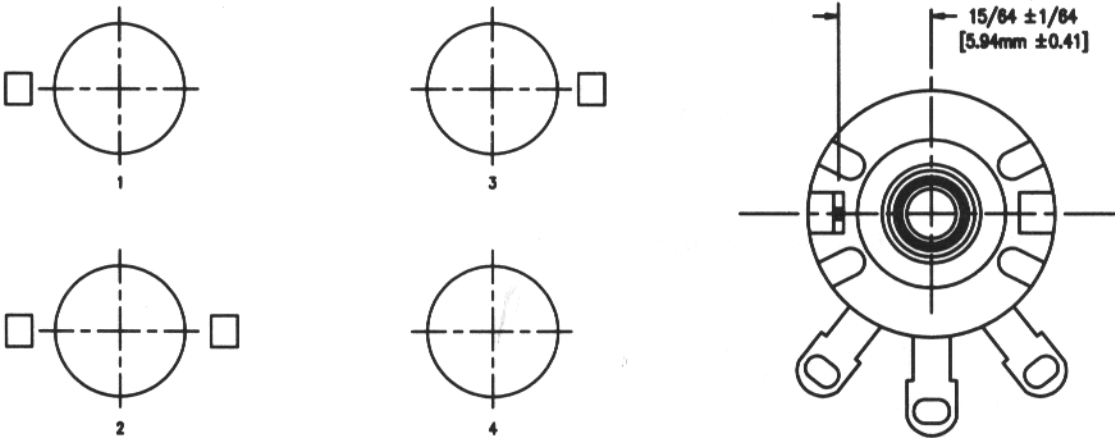
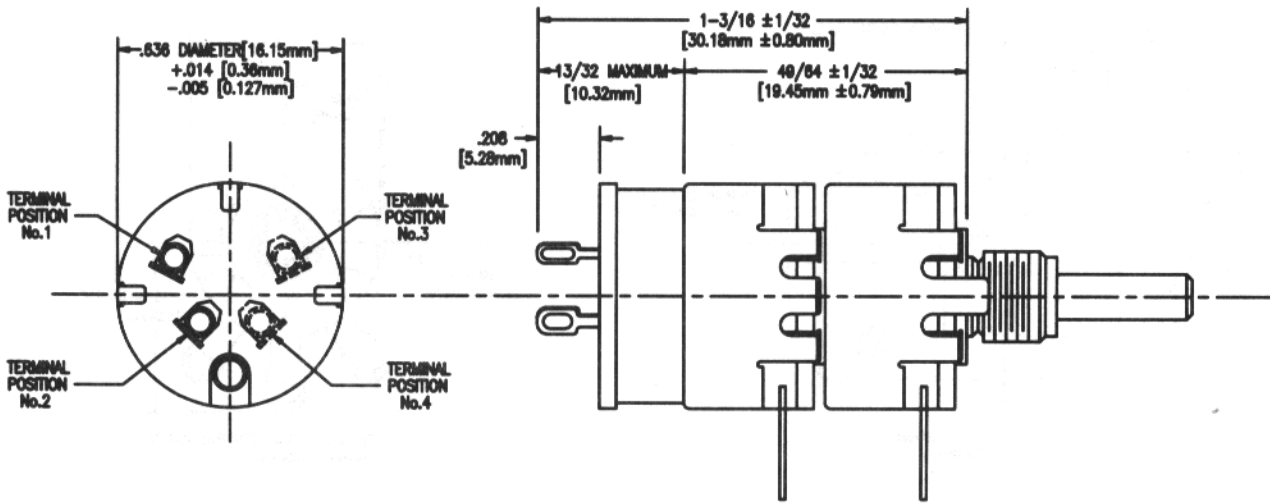

Figure 7

Series 381 Dual Potentiometer Construction With Rotary Switch Options



Type No. Operation	Switch Variation	Terminal Position	Maximum Operating Torque—In Oz.
*B-10 CCW Terminal	D.P.S.T. 1A, 125V. (AC or DC) 4A, 20V. (DC Only)	1-2-3-4	15
B-16 CCW Terminal	S.P.S.T. 1A, 125V. (AC or DC) 4A, 20V. (DC Only)	1-2	15
B-17 CW Terminal	S.P.S.T. 1A, 125 V. (AC or DC) 4A, 20V. (DC Only)	1-2	15

Unless otherwise specified, switches operate at extreme CCW rotation, and may be ordered either normally open or normally closed. Switching operations normally open and normally closed at the CW terminal also available.

*May be employed as a single pole, single throw, two circuit switch.

Figure 8

Series 381 Single Potentiometer Concentric Shaft Operated Switch

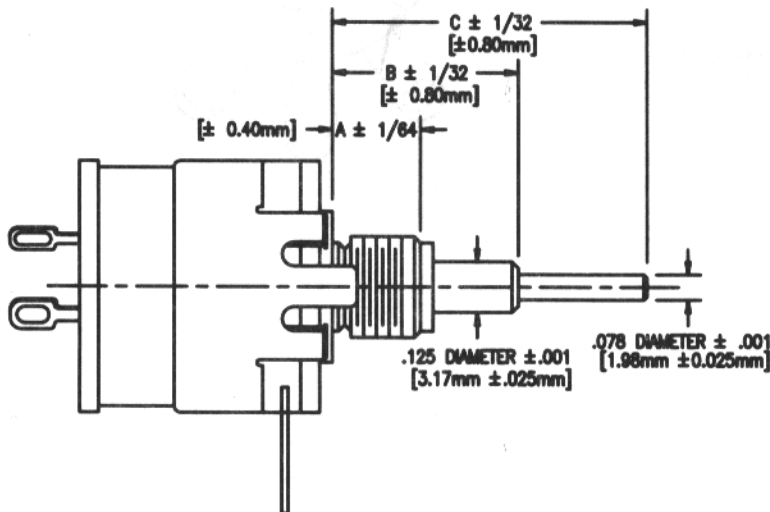

Figure 9

Series 381 Triple Potentiometer Construction

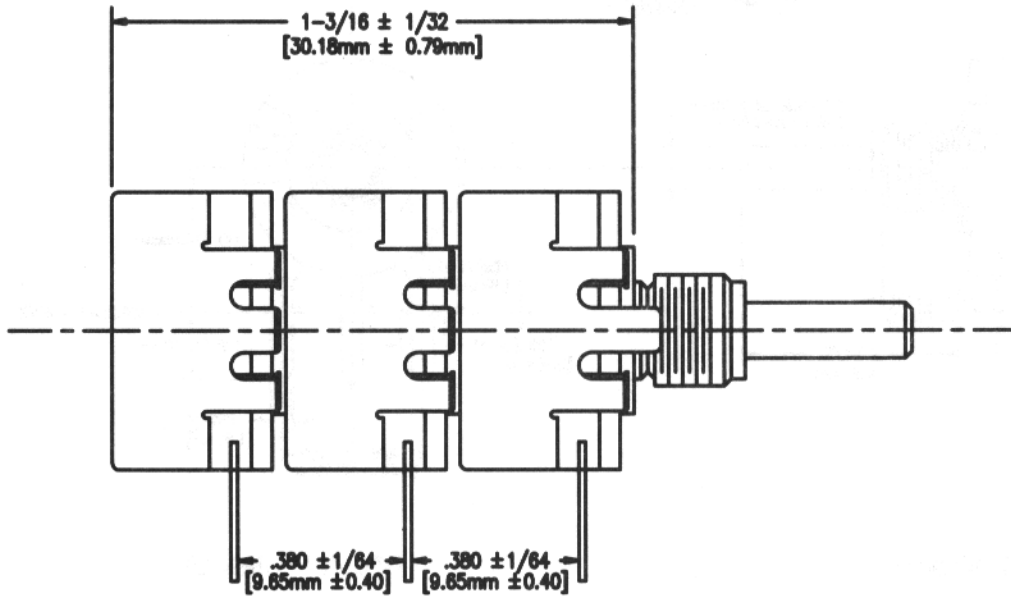

Figure 10

Series 381 Dual Potentiometer Construction
Concentric Shafts Operated

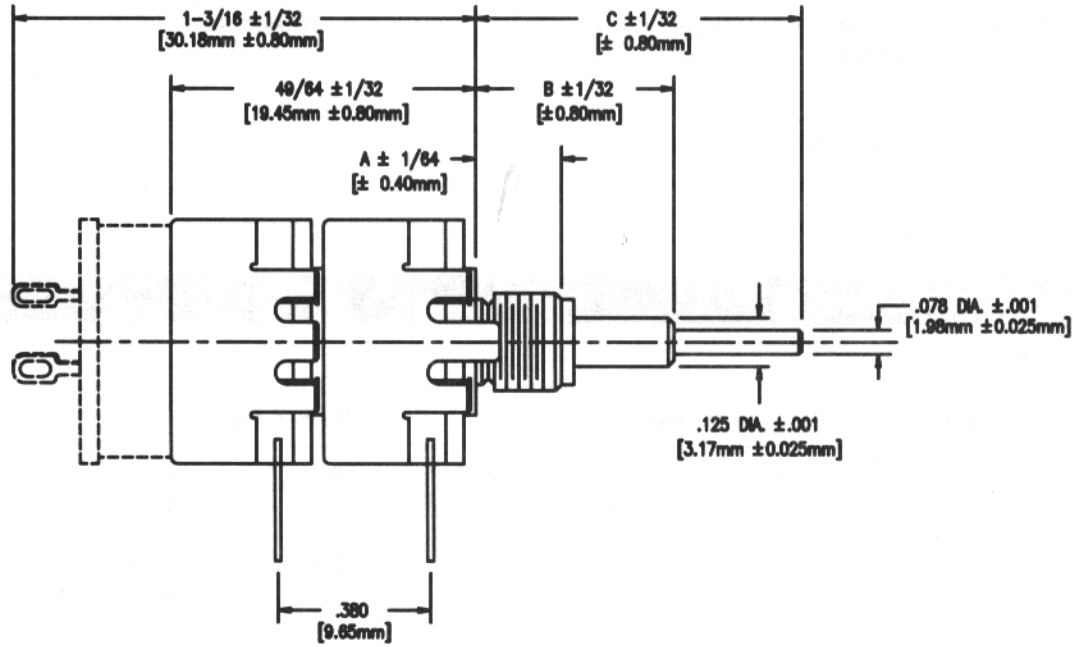
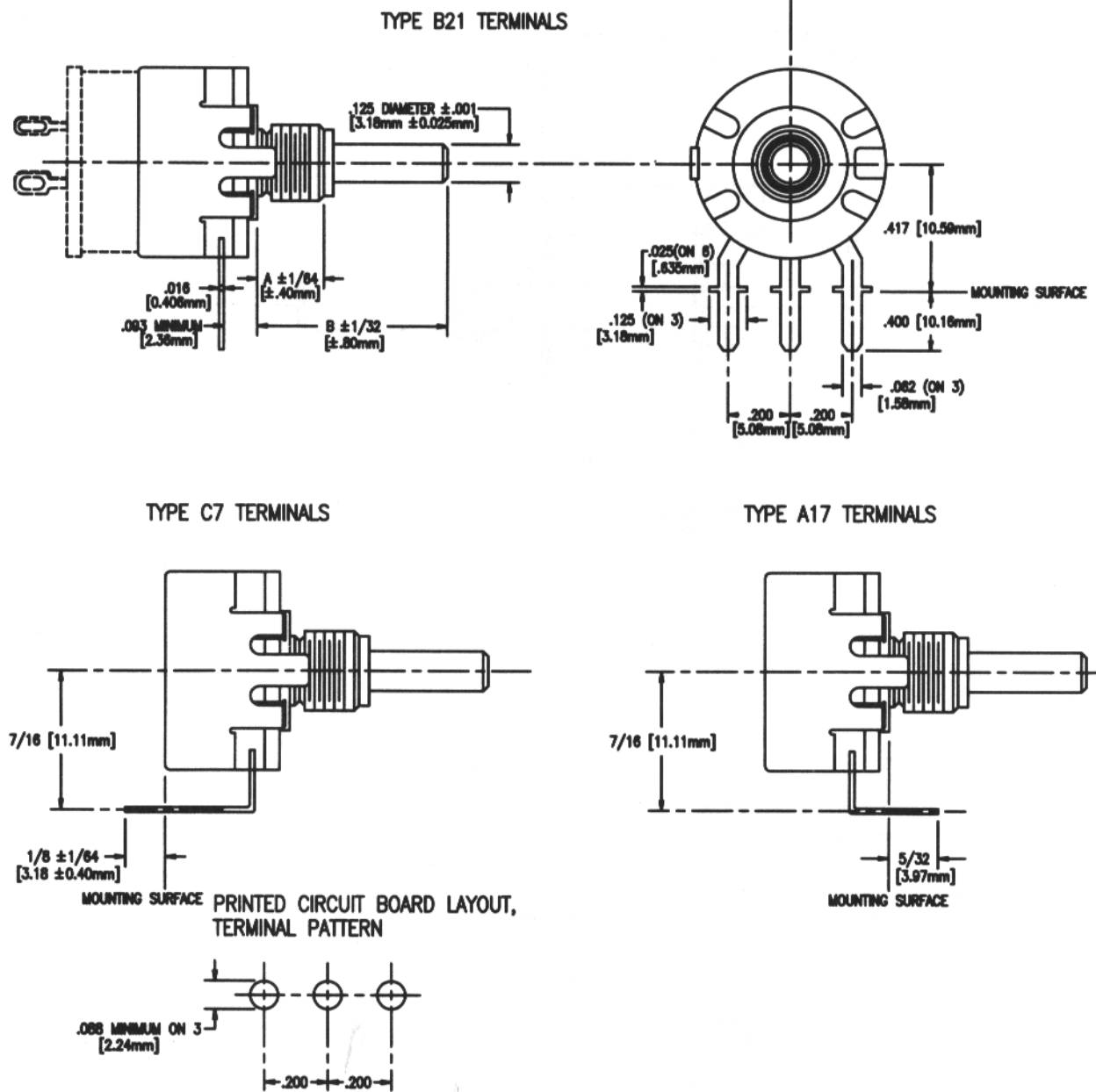

Figure 11

Series 381 Printed Circuit Terminals



Series 381 Standard Resistance Values

Stock Values (ohms)

381N, 381NS, 381L Linear			D381N Linear			381N-Z Taper	
100	5K	250K	500	5K	50K	1000*	50K
250	10K	500K	1000	10K	100K*	2500	100K
500**	25K	1 Meg	25K			5K	250K
1000	50K	2.5 Meg**				10K	500K*
2500	100K	5 Meg**				25K	1 Meg

*Made to order only. Please consult Factory.

**Made to order in 381NS style. Please consult Factory.

Series 381 How To Order

<i>Catalog Number</i>	<i>Description</i>
381N	Bushing, Plain, 1/4 in. (6.35mm) long. Shaft 3/4 in. (19.05mm) FMS screwdriver slotted.
381NS	Bushing (same as 381N) but equipped with a factory attached S.P.S.T. switch. 1a, 125V (ac or dc).
*381N-Z	Bushing - Z-Taper.
381L	Locking bushing, 3/8 in. (9.35mm) long. Shaft, 7/16 in. (11.11mm) long. FMS screwdriver slotted.
D381N	Dual ganged. Bushing and shaft same as 381N.

*NOTE: Insert Resistance Value between N and Z for complete Catalog Number, e.g., 381N-10K-Z.

Catalog Number + Resistance + Taper

Example: **381N-100-S**

